













SPECIFICHE TECNICHE

rev. 02/23 1.0

Peso attrezzatura / Peso del implemento	 kg	kg	780
Peso macchina portante / Peso macchina portadora		ton	10-16
Portata olio escavatore / Caudal de aceite	 	l/min	80-100
Pressione di esercizio / Presión de trabajo	 	bar	300
Portata di olio rotazione / Caudal de aceite necesario para la rotación	 	l/min	15-20
Pressione esercizio rotazione / Presión para la rotación	 	bar	190
Forza di chiusura / Fuerza de cierre		kN	35
A		mm	1065
B		mm	485
C		mm	1700
D		mm	800
Capacità / Capacidad		l	400

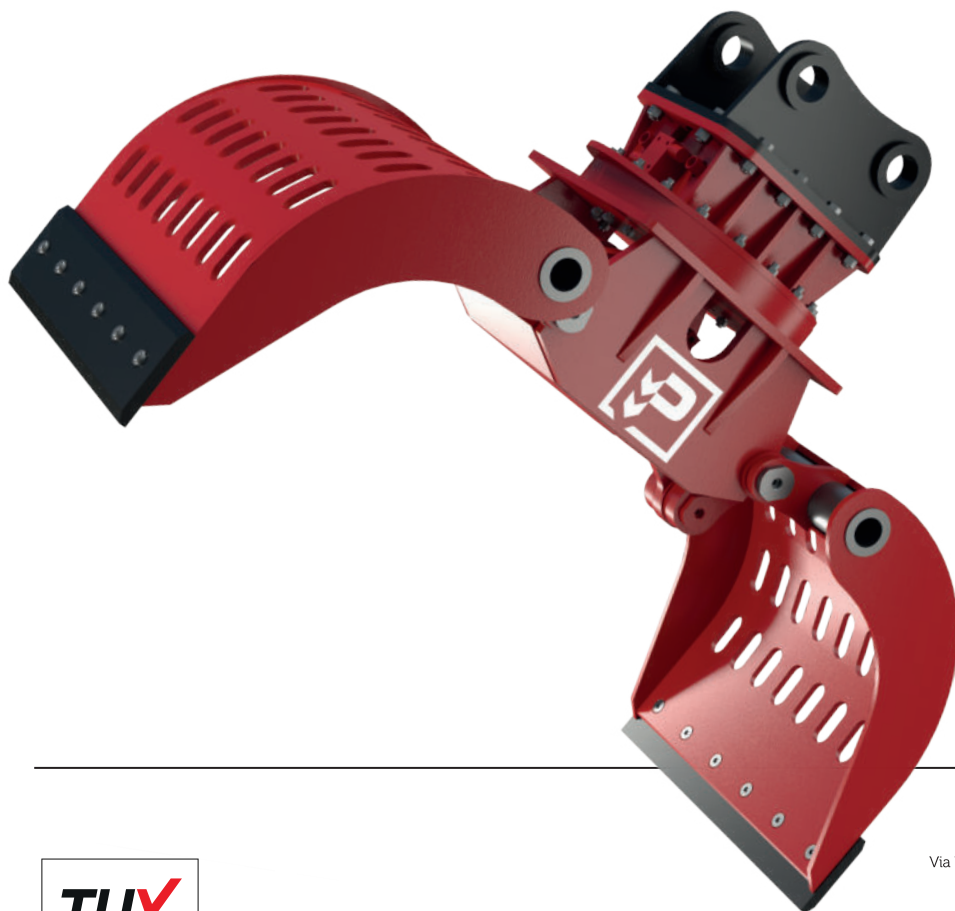
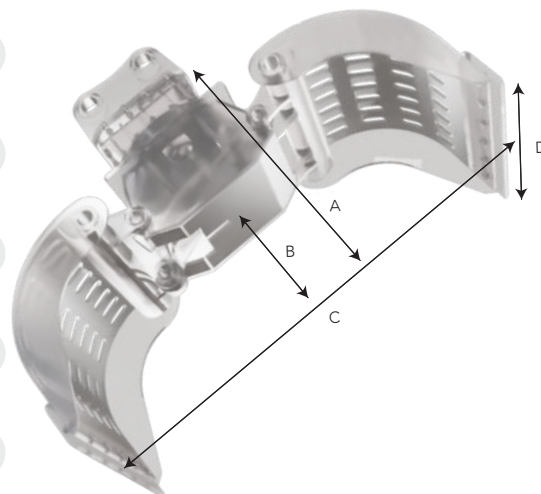

Rev. Feb. 2023

Promove srl

Via Luigi Gambardella 10 - 70056 Molfetta, Bari - Italy

+39 080 3387054

+39 393 9163160

promovedemolition.com

info@promovedemolition.com

