

TECHNICAL SPECIFICATION

rev. 02/23 1.0

Equipment weight / Poids de l'équipement / Eigengewicht	 body	kg	1200
Carrier weight / Poids du porteur / Dienstgewicht des Trägergeräts		ton	16-20
Oil flow / Débit d'huile / Öldurchfluss		l/min	100-120
Working pressure / Pression de travail / Betriebsdruck		bar	300
Rotation oil flow / Débit d'huile rotation / Drehmotor Ölbedarf		l/min	20-25
Rotation pressure / Pression de rotation / Drehmotor Betriebsdruck		bar	190
Closing Force / Force de fermeture / Schließkraft		kN	43
A		mm	1250
B		mm	515
C		mm	1950
D		mm	1000
Capacity / Capacité / Inhalt		l	650

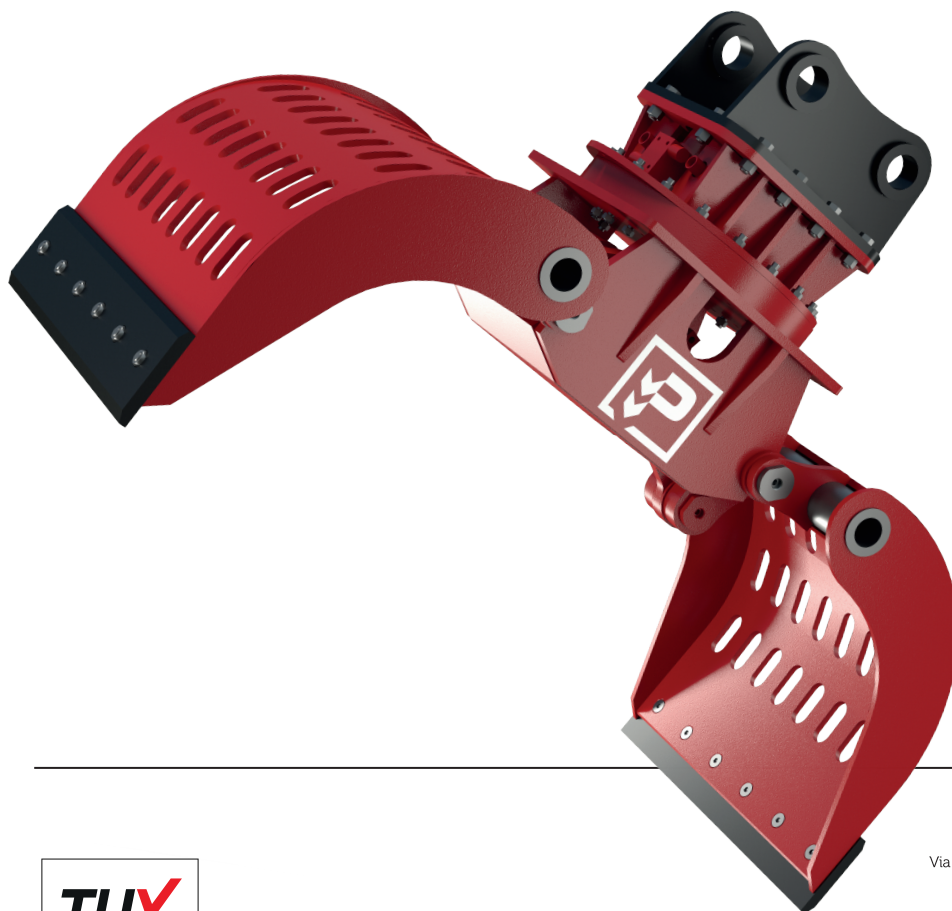
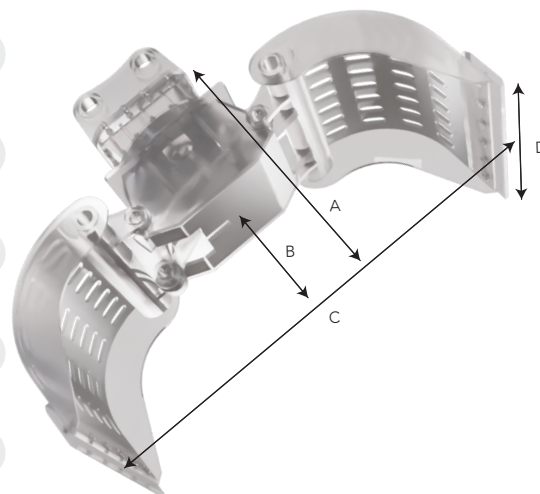

Rev. Feb. 2023

Promove srl

Via Luigi Gambardella 10 - 70056 Molfetta, Bari - Italy

+39 080 3387054

+39 393 9163160

promovedemolition.com

info@promovedemolition.com

